

Operator's Instruction Manual

GMS-14A



Shown with optional
Stand

14" Gasoline Powered Masonry Saw with Controlled Dust Operation



100 Thomas Johnson Drive, Frederick, MD 21702-4600 USA
Phone (301) 663-1600 • 1-800-638-3326
Fax (301) 663-1607 • 1-800-447-3326
Website: www.edcoinc.com • Email: sales@edcoinc.com

Printed in USA
© 2002

READ AND UNDERSTAND THE OPERATORS INSTRUCTION MANUAL THOROUGHLY BEFORE ATTEMPTING TO OPERATE THIS EQUIPMENT.



Death or serious injury could occur if this machine is used improperly.



SAFETY MESSAGES

- Safety Instructions are preceded by a graphic alert symbol of DANGER, WARNING, or CAUTION.

DANGER Indicates an imminent hazard which, if not avoided, will result in death or serious injury.

WARNING Indicates an imminent hazard which, if not avoided, can result in death or serious injury.

DANGER Indicates hazards which, if not avoided, could result in serious injury and or damage to the equipment.

GASOLINE POWERED EQUIPMENT

 Engine exhaust from this product contains chemicals known in certain quantities, to cause cancer, birth defects or other reproductive harm.

- Gasoline is extremely flammable and poisonous. It should only be dispensed in well ventilated areas, and with a cool engine.

DANGER Do not operate gasoline powered equipment without adequate ventilation. Carbon monoxide is an invisible, odorless gas that can kill.

ELECTRICAL POWERED EQUIPMENT



• Extreme care must be taken when operating electric models with water present: Ensure power cord is properly grounded, is attached to a Ground-Fault-Interrupter (GFI) outlet, and is undamaged.

- Check all electrical cables - be sure connections are tight and cable is continuous and in good condition. Be sure cable is correctly rated for both the operating current and voltage of this equipment.

WARNING Improper connection of the equipment-grounding conductor can result in a risk of electric shock. Check with qualified electrician or service person if there is any doubt as to whether the outlet is properly grounded. Adhere to **all** local codes and ordinances.

- **NOTE:** In the event of a malfunction or breakdown, grounding provides a path of least resistance for the electric current to dissipate. The motor is equipped with a grounded plug and must be connected to an outlet that is properly installed and properly grounded. **DO NOT** modify the plug provided on the motor. If the plug does not fit the outlet have a qualified electrician install the proper receptacle.
- Switch motor **OFF before** disconnecting power.
- Do not disconnect power by pulling cord. To disconnect, grasp the plug, not the cord.
- Unplug power cord at the machine when not in use and before servicing.

GENERAL INSTRUCTIONS



Read and understand these instructions thoroughly before attempting to operate this equipment. Different models have different parts and controls, death or serious injury could occur if the machine is used improperly.

- Equipment should only be operated by trained personnel in good physical condition and mental health (not fatigued). The operator and maintenance personnel must be physically able to handle the bulk weight and power of this equipment.
- This is a one person tool. Maintain a safe operating distance to other personnel. It is the **operators' responsibility** to keep other people (workers, pedestrians, bystanders, etc.) away during operation. Block off the work area in all directions with roping, safety netting, etc. for a safe distance. Failure to do so may result in others being injured by flying debris or exposing them to harmful dust and noise.
- This equipment is intended for commercial use.
- For the operators safety and the safety of others, always keep all guards in place during operation.
- Never let equipment run unattended.
- Personal Protection Equipment and proper safety attire must be worn when operating this machinery. The operator must wear approved safety equipment appropriate for the job such as hard hat and safety shoes when conditions require. Hearing protection **MUST** be used (operational noise levels of this equipment may exceed 90db) . Eye protection **MUST** be worn at all times. A dust/particle respirator must be used when cutting or grinding without an adequate dust control system in place.



Keep body parts and loose clothing away from moving parts. Failure to do so could result in dismemberment or death.

- Do not modify the machine. Use only genuine **EDCO** parts and accessories. Repairs and service should be performed by **EDCO** or by approved **EDCO** dealers or repair technicians.
- Stop motor/engine when adjusting or servicing this equipment.



Maintain a safe operating distance from flammable materials. Sparks from the cutting-action of this machine can ignite flammable materials or vapors.

- Always keep all guards in place during operation for the operators' safety and the safety of others.

EXHAUST HAZARD



Engine exhaust from this product contains chemicals known to the State of California to cause cancer, birth defects or other reproductive harm.

- This equipment will create dust from the material being removed. That dust may contain chemicals known to the State of California to cause cancer and/or birth defects or other reproductive harm. Check the chemical properties of the material to be removed and take the appropriate precautions.



Equipment Instruction Manual

EDCO GMS-14A

Section	Page Number
Safety Guidelines.....	4
Operating Instructions.....	5-7
Maintenance.....	8-10
Maintenance Schedule.....	11
Limited Equipment Warranty.....	12

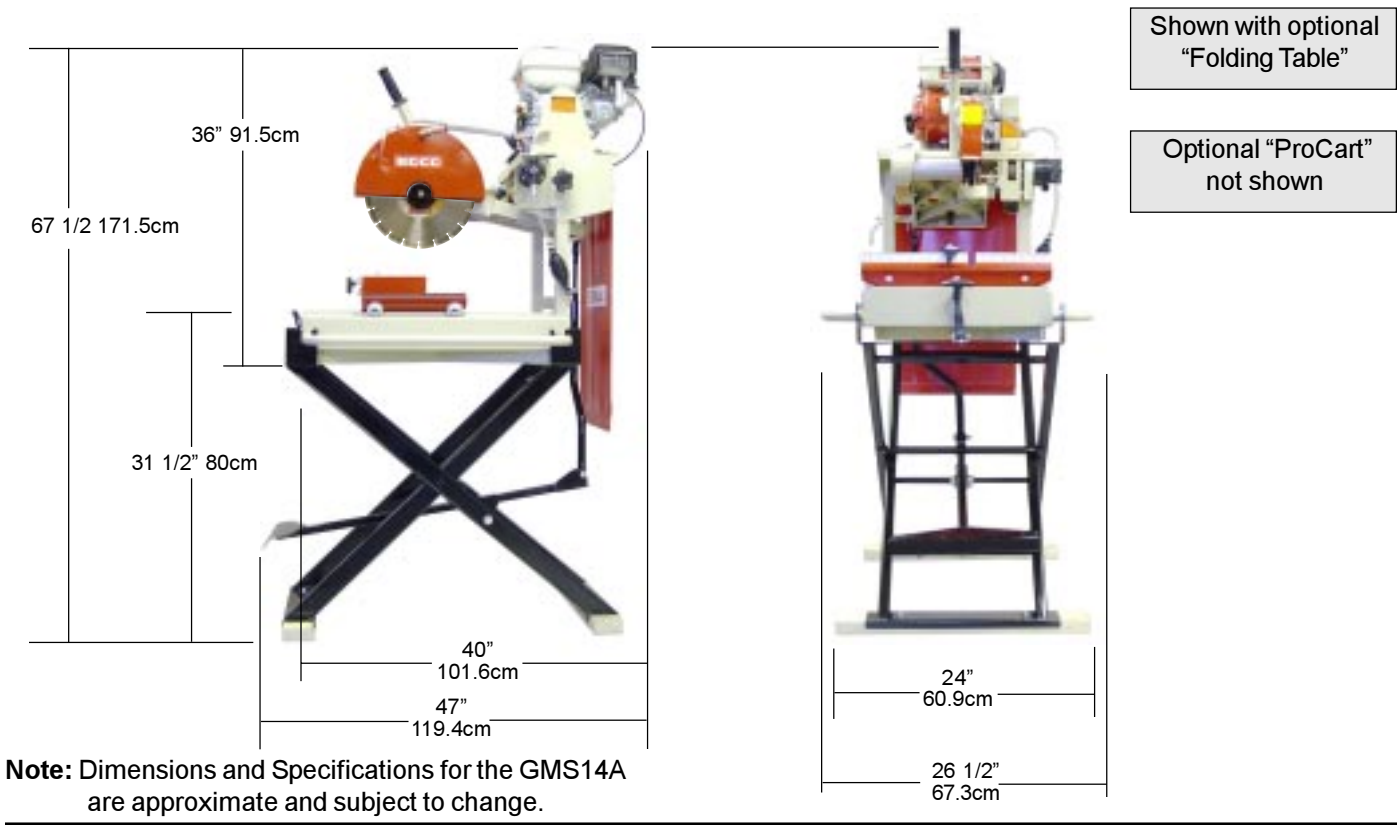

Figure 1

HOW TO ORDER REPAIR PARTS

To insure product safety and reliability, always use genuine EDCO replacement parts when making repairs to the equipment.

When ordering parts, please specify the MODEL and SERIAL NUMBER of the machine as given on the NAMEPLATE. In addition, give part number, description and quantity as listed on the parts list.

Please note: Due to improvements and changes in the equipment the illustrations shown may be different from the actual machine.

Toll Free: Voice 1-800-638-3326 • Fax 1-800-447-3326

Overall Dimensions without optional stand		
Height	36"	91.5cm
Width	26 1/2"	67.3cm
Length	40"	101.6cm





Read and understand this *Operator's Instruction Manual*,
and the *Engine Manufacturer's Owner's Manual*
before operating this equipment.
Death of serious injury can result if this machine is used improperly.



Safety Guidelines



Eye and ear protection must be worn at all times while the GMS-14A is in use. During normal operation, sound pressure levels exceed 92dBA. Use only ANSI approved safety glasses to help prevent eye injury. Everyday eyeglasses have only impact resistant lenses; they are NOT safety glasses.



Operator must wear appropriate clothing and footwear. Do not wear loose clothing or jewelry that can get tangled in moving parts. Footwear should provide sure footing and protection from debris that may be dropped. Take steps to be sure hair will not be caught in moving parts. If necessary, tie it back.



Disconnect the spark plug wire lead before performing any service on the machine. (Figure 4, Item W)

- When loading or unloading the saw, use caution. Make sure rolling table is locked so that the blade will not be damaged. (Figure 3, Item O) Do not move the saw while the engine is running.
- This unit is shipped new from the factory without oil or gasoline, it will need to be added before it is used. Check the *Engine Manufacturer's Owner's Manual* for instructions on break-in, servicing and use of engine.



This GMS-14A gasoline powered saw is designed to be used in areas where electrical power is not available. Do not operate gasoline-powered equipment without adequate ventilation. The exhaust fumes contain carbon monoxide, an invisible, odorless gas that can kill.



This machine is designed to cut interlocking pavers, retaining wall block and brick. The work piece must be placed on the rolling table surface and the table used to move the work piece to the blade. Cut only in a straight line. Do not force or twist the work piece into the blade. Personal injury or damage to the equipment or blade can result.

- Never exceed the maximum operating speed of the blade. Match the blade speed rating with the arbor shaft speed. (See page 9)
- Never leave the saw running unattended.
- Never operate this saw under the influence of drugs, alcohol or when taking medications that impair the senses or reactions, or when excessively tired or under stress.
- Make sure all safety decals can be clearly read and understood. Replace damaged or missing decals immediately.

Safety warnings and guidelines do not by themselves eliminate danger.
They are not given as substitutes for proper accident prevention procedures and good judgement.

Operating Instructions

Diagrams shown with Honda Cyclone Dual-Filter Element Engine as an example. Consult the *Engine Manufacturer's Owner's Manual* for information on specific models.

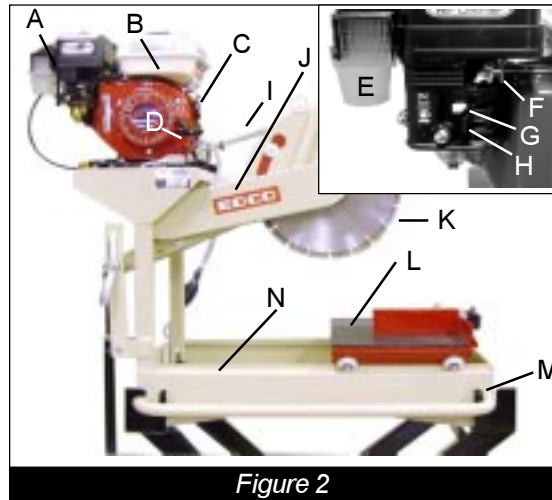

- A. Air Filter
- B. Fuel Tank
- C. On/Off Switch
- D. Recoil Starter
- E. Cyclone Housing
- F. Engine Throttle
- G. Choke
- H. Fuel Valve Lever
- I. Water Hose
- J. Belt Guard
- K. Diamond Blade
- L. Rolling Table
- M. Water Tray
- N. Water Tray Drain/Plug

- O. Blade Guard Level Rod
- P. Back Stop
- Q. Water Pump Primer Bulb
- R. Right Angle Guide Bar
- S. Blade Guard
- T. Water Pump
- U. Optional Table

- V. Muffler
- W. Spark Plug Lead
- X. Oil Drain
- Y. Dip Stick/Filler Cap

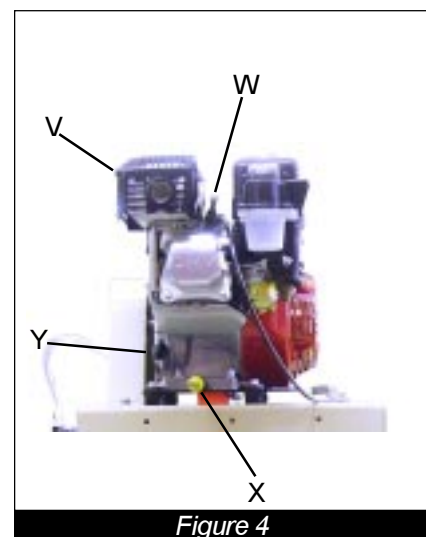
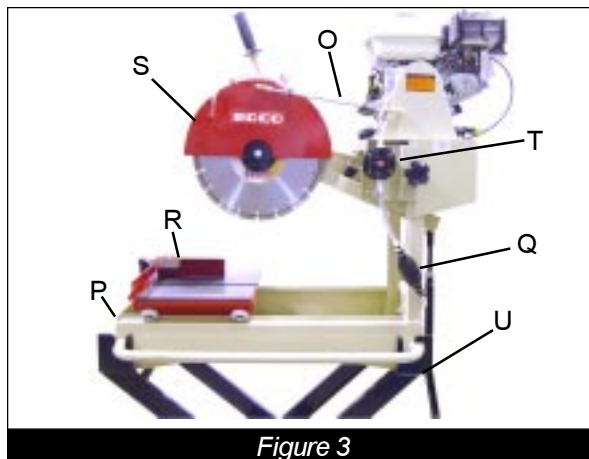

Before Starting Engine:

- Read and understand the instructions supplied by the engine manufacturer.
- Familiarize yourself with all engine and saw controls. (Figures 2-4)
- Visually inspect the entire machine for damage or wear. Look for signs of oil or fuel leaks. Remove excess dirt or debris. Check that all nuts, bolts and screws are tightened. Check for proper alignment of moving parts, possible binding of moving parts, breakage of parts, loose mounting brackets, and any other condition that might affect operation.
- Inspect diamond blade and arbor shaft. Check blades for cracks, loose segments, worn or out-of-round arbor holes. Do not use warped, twisted, out-of-balance blades or any blade of questionable condition. (Figure 8)
- Check engine oil. Make sure that it is at the proper level and that it is clean.
Note: Some engines have an Oil Alert System that will automatically stop the engine before the oil level falls below the safe limit. To avoid an unexpected shut down, check the oil level regularly during operation.
- Check the fuel level. Do not over fill fuel tank and never refuel a hot engine. If refueling is necessary during operation, allow engine to cool down first.
- Inspect the air filter to be sure it is clean.
- If wet cutting, fill the water tray with water. The water pump recycles the water from the tray, plug the drain hole and be sure the water is circulating from the tray to the water pump.
- If wet cutting, with an external source of water, such as a water barrel, open the drain plug in the water tray and make sure the water has somewhere to go that is clear of the working area. One option is to hook up a second hose. (Figure 6)
- If dry cutting, attach a vacuum to the end of the optional dust hood. (Figure 7)
Note: While the GMS-14A was designed to be used with a standard shop vac, EDCO recommends using a heavy duty vacuum such as the VAC-150. The VAC-150 has the advantage of a Self-Purging System to help keep concrete dust from building up on the filter and a larger filter area to maintain performance during use, thus reducing time wasted on frequently cleaning a standard shop vac and filter media.

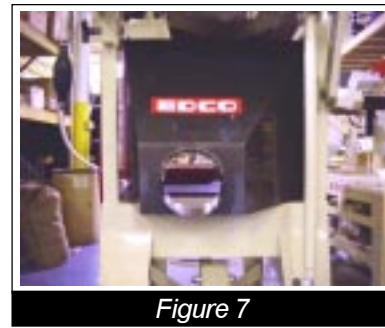
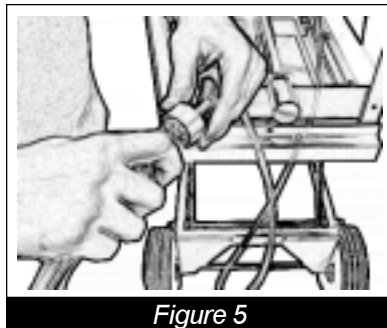

Starting the Engine:

- Be sure blade is clear of item to be cut.
- Determine that the recoil starter assembly turns freely, starter rope pulls easily, and the rope retracts properly.
- Follow the instructions supplied in the engine manufacturer's *Owner's Manual* for starting engine.
- Open the throttle and allow engine to reach operating temperature.
Note: To ensure that the necessary power is transferred to the blade, all cutting must be done at *full throttle*. The governor is factory set for correct speed - altering this setting will damage the machine. Maintain the engine according to factory specifications.

Cutting:

- Place the work piece on rolling table against the backstop and use the rolling table to move the work piece to the blade. Do not strain the engine while cutting or jam work piece into the blade. Do not twist the work piece while cutting.
- Do not reach underneath or around work piece while the blade is rotating.
- Keep stable footing at all times while cutting.



Keep hair, clothing, fingers and all body parts away from the blade and any other moving parts.

- For wet cutting, maintain an adequate supply of water to cool the blade.

Note: If using the optional water pump, clean water must be run through the cycle daily to avoid build up in the pump.

- When you have finished cutting, return throttle to idle. Stop the engine by returning the engine mounted stop switch to the OFF position. Do not leave the saw running unattended.
- Clean dust and debris from entire machine.

IMPORTANT REMINDER: This machine is designed to use diamond blades to cut pavers, stone, tile, masonry products and brick. Do not use it to cut anything else.

Refer to the
Rx for Diamond Blades
for more detailed information
on diamond blades.

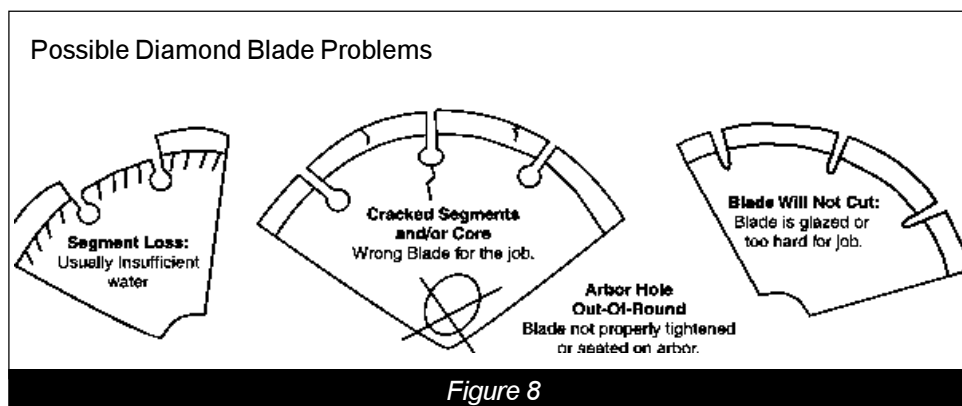

100 Thomas Johnson Drive, Frederick, MD 21702-4600 USA
 Phone (301) 663-1600 • 1-800-638-3326
 Fax (301) 663-1607 • 1-800-447-3326
 Website: www.edcoinc.com • Email: sales@edcoinc.com

Printed in USA
© 2002



Disconnect spark plug lead before performing any maintenance on this machine.



Maintenance

Consult the *Engine Manufacturer's Owner's Manual* for more detailed engine maintenance instructions.

Changing the Blade:

- Inspect the new blade thoroughly before installing. Check for cracks, loose segments, worn or out-of-round arbor holes. Refer to the *Rx for Diamond Blades* pamphlet provided with your blade for more detailed information on inspecting blades. Be sure the blade is appropriate for the job and matches the arbor speed and mounting configuration on this saw. (See page 9)

The GMS-14A was designed to be used with diamond saw blades



Figure 9

Step One:

Remove spark plug lead from spark plug.
Pull the rolling table all the way to the front of the machine.
Adjust and lock the blade/blade guard assembly into a comfortable working position as shown in (Figure 9).

Step Two:

Remove bolt and blade cap using a SAE 3/4" wrench (Figures 10 & 11) Carefully remove old blade. Inspect arbor shaft, backing plate and blade guard while blade is off. Clean if dirty or replace if damaged or worn.



Figure 10



Figure 11



Figure 12



Figure 13

Step Three:

Look for "direction of rotation" markings on the blade. (Usually an arrow stamped on the blade.) Place new blade on the arbor shaft verifying that once installed the markings on the blade follow the proper direction of rotation. (Figure 13)

Reinstall blade cap and tighten bolt using a SAE 3/4" wrench.

If moved in step #1, reposition blade/blade guard assembly and tighten. Reconnect spark plug lead.

Belt Adjustment and Replacement:

- Periodically check to be sure the belts are undamaged and that they are at the proper tension. Slipping belts will overheat causing the cutting speed to be limited, shortening the life of the belts. Over-tensioned belts will shorten the life of the belts & bearings.
- On new equipment and after installing new belts, be certain to re-tension the belts after the first 4 hours of use. New belts are stiff and require a break in period. Belts that become loose could slip and/or overheat.
- Damaged, stretched or excessively worn belts should be replaced with a new complete set of belts.

IMPORTANT: Belts must be replaced as a set, even if only one belt is showing wear.



Figure 14

Remove belt guard (3 bolts) and inspect belts. A straight edge is a good tool to use to be certain sheaves are even and properly aligned. (Figure 14)

To tension belts, back off blade head assembly bearing bolts(4) and slide the blade head assembly forward or back until belts are at proper tension. (Figure 15) **NOTE:** Be sure to align blade after belt adjustment or belt replacement

To remove belts, back off bearing mounting bolts (4), slide blade head assembly forward or backward until belts slide off the sheaves. Place a complete set of new belts on the machine. Realign blade head assembly then tighten bolts. Reinstall belt cover.

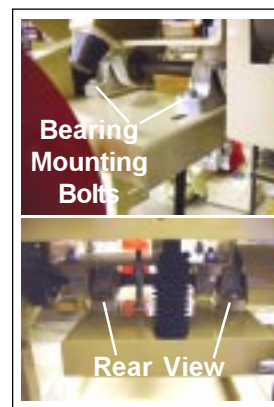

Figure 15

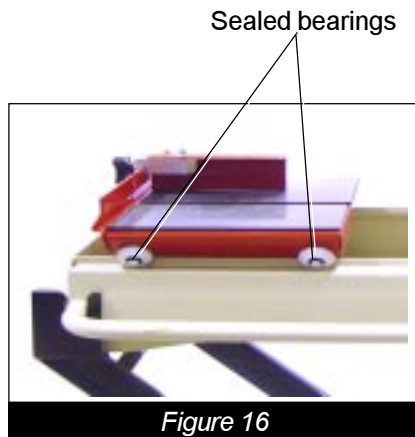

Figure 16

Clean Wheels on Rolling Table:

During daily visual inspection, check to be sure the wheels on the rolling table move smoothly and that there is no debris in the wheel tracks. (Figure 16)

No lubrication is necessary for the wheels because of sealed bearings. Replace damaged or worn wheels.

Use Diamond Blades Only	
Blade Diameter	14 inches
Arbor Shaft Diameter	1"
Max Cutting Depth	4 1/2"
Arbor Speed	3600 RPM



Change Engine Oil:

- Check Engine Oil before each operation. Open the filler cap and look at the dip stick. (*Figure 17*) Oil should be clearly visible both on the stick and in the cavity and should look fairly clean. Running the machine on dirty oil or when the oil is low will result in damage to the equipment.
- Change the Engine Oil after every 50 hours of operation or sooner as conditions require. Refer to the Engine Manufacturer's Owner's Manual for specific viscosity recommendations and changing instructions.

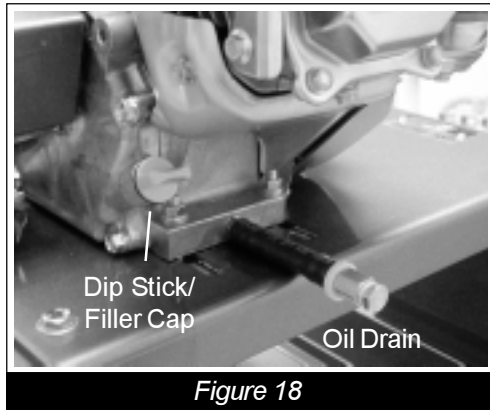
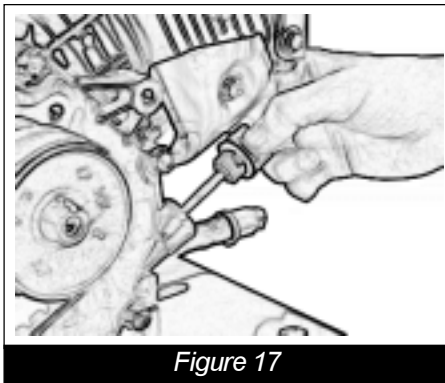

Inspect and Clean Oil Air Filter:

Shown with Honda Cyclone Dual Filter style element.
Outer foam filter (*Figure 19*) is removable for cleaning.

Refer to the Engine Manufacturer's Owner's Manual
for instructions on specific models.

Check air filter at least once daily. (*Figure 20*)
Dirt build up on the filter will cause the engine to wear out faster.

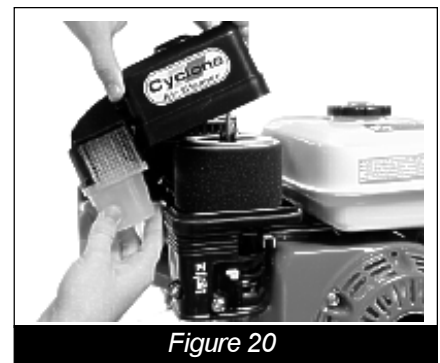
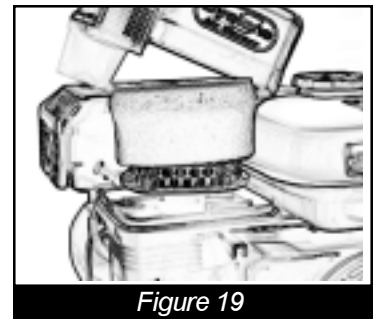



Repairs are to be done by authorized EDCO DEALERS only.



Read and follow instructions in the Engine Manufacturer's Manual

Maintenance Schedule

This is for a quick reference to the information supplied in the Maintenance portion of this manual.

Follow the Engine Manufacturer's Maintenance Instructions	Before Operation	Daily	After Operation	Every 50 Hours of Operation	As Required	Annually
Visually Inspect Entire Machine and Hardware	X					
Check Engine Oil	X					
Inspect Blade and Arbor Shaft	X					
Inspect Guards		X				
Clean and Oil Air Filter		X				
Clean Dust and Dirt Off Machine			X			
Change Engine Oil				X		
Inspect Belts					X	
Lubricate Wheels on Rolling Table					X	
Replace Spark Plug						X



LIMITED EQUIPMENT WARRANTY

Equipment Development Company, Inc. herein referred to as EDCO warrants that each new unit manufactured by EDCO to be free from defects in material and workmanship in normal use and service for a period of (1) one year (except in the case of the cutter drum assembly on all model concrete asphalt planes, in which case the warranty period shall be 90 days) from date of shipment to the original buyer or equipment rental center owner.

EDCO will, at its option, repair or replace, at the EDCO factory or at a point designated by EDCO any part, which shall appear to the satisfaction of EDCO inspection to have been defective in material or workmanship.

This warranty, does not apply to failure occurring as a result of abuse, misuse, negligent repairs, corrosion, erosion, normal wear and tear, alterations or modifications made to the product without express written consent of EDCO: or failure to follow the recommended operating practices and maintenance procedures as provided in the products operating and maintenance manuals.

This warranty does not obligate EDCO to bear any transportation charges in connection with the replacement or repair of defective parts. This warranty does not obligate EDCO to bear any expense for travel time or of personnel in connection with any service calls.

Accessories or equipment furnished and installed on the product by EDCO but manufactured by others, including but not limited to engines, motors, electrical equipment, transmissions, etc., shall carry the accessory manufacturers' own warranty.

THIS WARRANTY IS IN LIEU OF ALL OTHER WARRANTIES, EXPRESSED OR IMPLIED, OR STATUTORY, INCLUDING ANY WARRANTIES OF MERCHANTABILITY OR OF FITNESS FOR A PARTICULAR PURPOSE.

LIABILITY LIMITATIONS

The remedies of the user set forth under provisions of warranty outlined above are the exclusive and total liability of EDCO with the respect to their sale or the equipment and service furnished hereunder, in connection with the performance or breach thereof, or from the sale, delivery, installation, repair or technical direction covered by or furnished under the sale, whether based on contract, warranty, negligence, indemnity, strict liability, or otherwise shall not exceed the purchase price of the unit of equipment upon which such liability is based.

EDCO will not in any event be liable to the user, any successors in interest or any beneficiary or assignee relating to this sale for any consequential, incidental, indirect, special or punitive damages arising out of this sale or any breach thereof, or any defects on, or failure of, or malfunction of the equipment under this sale based upon loss of use, lost profits or revenue, interest, lost goodwill, work stoppage, impairment of other goods, loss by reason of shutdown or non-operation, increased expenses of operation of the equipment, cost of purchase or replacement power of claims of users or customers of the user for service interruption whether or not such loss or damage is based on contract, warranty, negligence, indemnity, strict liability, or otherwise.

EDCO reserves the right to modify, alter and improve any part or parts without incurring any obligation to replace any part or parts previously sold without such modified, altered or improved part or parts.

No person is authorized to give any other warranty or to assume any additional obligation on EDCO's behalf unless made in writing and signed by an officer of EDCO.

Equipment Development Company, Inc.

USE ONLY GENUINE EDCO PARTS AND ACCESSORIES

For your own safety, the safety of others and the life of your machine

