



EQUIPMENT DEVELOPMENT COMPANY, INC.

2025
PRODUCTS & ACCESSORIES
PRICE LIST



Scan the QR Code Above to Download a Copy of the Price List

This page is intentionally left blank.

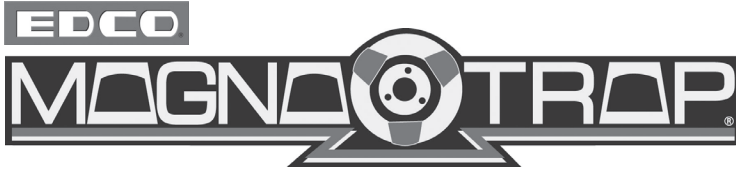

FLOOR GRINDERS

SINGLE-DISC Floor Grinder

PART#	MODEL	POWER	MSRP
59800	SEC-NG	1.5HP-115V	\$5,600.00



SINGLE-DISC FLOOR GRINDER SEC-NG

SINGLE-DISC Tooling Packages

PART#	ITEM	DESCRIPTION	MSRP
M103	Medium Concrete (Grey) Tooling Rental Package	3 Magna-Blades (Left Hand), 3 Double Dyma-Dots, 3 Dyma-Segs, 3 PCD w/Backing Segment (Left Hand) ProTungsert III (6 Pack)	\$853.00
M104	Soft Concrete (Yellow) Tooling Rental Package	3 Magna-Blades (Left Hand), 3 Double Dyma-Dots, 3 Dyma-Segs, 3 PCD w/Backing Segment (Left Hand) ProTungsert III (6 Pack)	\$853.00

DUAL-DISC Floor Grinder

PART#	MODEL	POWER	MSRP
59200	2EC-NG	1.5HP, 115/230V	\$7,506.00
59600	2EC-NG-3HP	3HP, 230V	\$7,927.00
59300	2GC-NG	13HP, Honda	\$9,220.00



DUAL-DISC FLOOR GRINDER 2EC-NG

HEAVY-DUTY DUAL-DISC Floor Grinder

PART#	MODEL	POWER	MSRP
58100	2D-HDE	5HP, 230V	\$13,467.00
58200	2D-HDP	18HP, 12V, Propane	\$15,230.00

HEAVY -DUTY DUAL-DISC FLOOR GRINDER 2D-HDE



*Rigid Head Assembly Standard. Inquire for Flex Head option

DUAL-DISC Tooling Packages

PART#	ITEM	DESCRIPTION	MSRP
M101	Medium Concrete (Grey) Tooling Rental Package	6 Magna-Blades (3 Left Hand & 3 Right Hand), 6 Double Dyma-Dots, 6 Dyma-Segs, 6 PCD w/Backing Segment (3 Left Hand & 3 Right Hand) ProTungsert III (6 Pack)	\$1,543.00
M102	Soft Concrete (Yellow) Tooling Rental Package	6 Magna-Blades (3 Left Hand & 3 Right Hand), 6 Double Dyma-Dots, 6 Dyma-Segs, 6 PCD w/Backing Segment (3 Left Hand & 3 Right Hand) ProTungsert III (6 Pack)	\$1,543.00

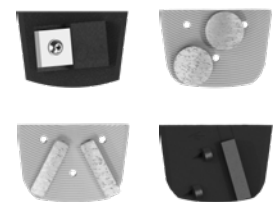

MAGNA-TRAP® CORE 4 TOOLING

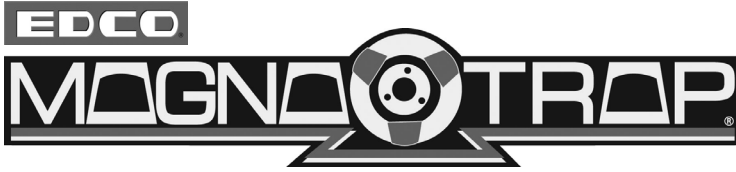

TURBO GRINDERS

7" EDGE Turbo Grinder

PART#	MODEL	POWER	MSRP
57200	TMC-7E	2HP, 115V	\$4,706.00

**Flex Head with Cropped Shroud Standard. Inquire for Rigid Head and Full Round Shroud options.*



7" EDGE
TURBO GRINDER
TMC-7

9" TURBO-LITE Turbo Grinder

PART#	MODEL	POWER	MSRP
58900	TL-9	1.5HP, 110V	\$4,315.00

9" TURBO-LITE
TURBO GRINDER
TL-9



10" Turbo Grinder

PART#	MODEL	POWER	MSRP
56600	TG-10G	13HP Honda	\$7,355.00
56900	TG-10E	5HP, 230V 1Phase	\$7,355.00
56700	TG-10P	13HP, Propane	\$11,305.00

**Rigid Head Assembly Standard. Inquire for Flex Head option.*



10" TURBO GRINDER
TG-10

TURBO GRINDER Tooling Packages

PART#	ITEM	DESCRIPTION	MSRP
M105	Medium Concrete (Grey) Tooling Rental Package	3 Double Dyma-Dots, 3 Dyma-Segs, 3 PCD w/Backing Segment (Left Hand)	\$393.00
M106	Soft Concrete (Yellow) Tooling Rental Package	3 Double Dyma-Dots, 3 Dyma-Segs, 3 PCD w/Backing Segment (Left Hand)	\$393.00

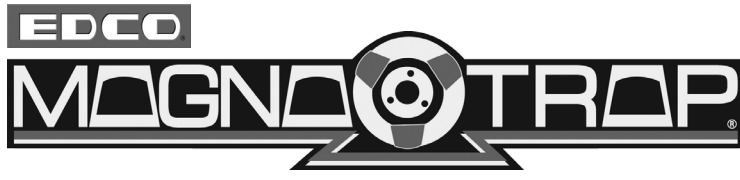

CORE & PRO TOOLING

Magna-Trap Core Tooling

PART#	ITEM	MSRP
12501LC	Magna-Blade Complete - LH (Single & Dual-Disc Grinders) Pack of 3	\$350.00
12501RC	Magna-Blade Complete - RH (Dual-Disc Grinders Only) Pack of 3	\$350.00
300101	Pro-Tungserts III 8-Sided Carbide Replacement 6 Pack (Magna-Blades and Magna-Trap Grinders)	\$151.00
QC2S-SC-0018	18-Grit Double Dyma-Segs (Soft Concrete, Yellow) Pack of 3	\$120.00
QC2S-MC-0018	18-Grit Double Dyma-Seg (Medium Concrete, Grey) Pack of 3	\$120.00
QC2S-HC-0018	18-Grit Double Dyma-Segs 18 Grit (Hard Concrete, Red) Pack of 3	\$120.00
QC2B-SC-0030	30-Grit Double Dyma-Dot (Soft Concrete, Yellow) Pack of 3	\$120.00
QC2B-MC-0030	30-Grit Double Dyma-Dot (Medium Concrete, Grey) Pack of 3	\$120.00
QC2B-HC-0030	30-Grit Double Dyma-Dot (Hard Concrete, Red) Pack of 3	\$120.00
QC2B-SC-0070	70-Grit Double Dyma-Dot (Soft Concrete, Yellow) Pack of 3	\$128.00
QC2B-MC-0070	70-Grit Double Dyma-Dot (Medium Concrete, Grey) Pack of 3	\$120.00
QC2B-HC-0070	70-Grit Double Dyma-Dot (Hard Concrete, Red) Pack of 3	\$128.00
QC2B-SC-0120	120-Grit Double Dyma-Dot (Soft Concrete, Yellow) Pack of 3	\$128.00
QC2B-MC-0120	120-Grit Double Dyma-Dot (Medium Concrete, Grey) Pack of 3	\$128.00
QC2B-HC-0120	120-Grit Double Dyma-Dot (Hard Concrete, Red) Pack of 3	\$128.00
QC-PCD1-LB	PCD w/Backing Segment - LH (Blue) (Single & Dual-Disc Grinders) Pack of 3	\$210.00
QC-PCD1-B	PCD w/Backing Segment - RH (Black) (Dual-Disc Grinders Only) Pack of 3	\$210.00
M501MC	Economy GRINDING Tool Blister Pack - Medium Concrete, Grey 3 Single Dyma-Segs	\$75.00
M501SC	Economy GRINDING Tool Blister Pack - Soft Concrete, Yellow Single Dyma-Segs	\$86.00

Magna-Trap PRO-Tooling

PART#	ITEM	MSRP
QC2V-MC-0030	30-Grit Dyma-Sharp (Medium Concrete) Pack of 3	\$165.00
QCPK-MC-0030-L	Dyma-Peak LH (Grey) (Single & Double-Disc Grinders) Pack of 3	\$225.00
QCPK-MC-0030-R	Dyma-Peak RH (Black) (Dual-Disc Grinders Only) Pack of 3	\$225.00
QC2S-RA-0030	Dyma-Rapida (Extremely Hard Concrete, Gold) Pack of 3	\$180.00
XL2B-SC-0030	XL 30-Grit Double Dyma-Dot (Soft Concrete, Yellow) Pack of 3	\$150.00
XL2B-MC-0030	XL 30-Grit Double Dyma-Dot (Medium Concrete, Grey) Pack of 3	\$150.00
XL2S-MC-0006	XL 6-Grit Dyma-Seg (Medium Concrete, Grey) Pack of 3	\$150.00
XL2S-MC-0018	XL 18-Grit Dyma-Seg (Medium Concrete, Grey) Pack of 3	\$150.00
XL2S-SC-0018	XL 18-Grit Dyma-Seg (Soft Concrete, Yellow) Pack of 3	\$150.00
QC1B-SC-0030	30-Grit Single Dyma-Dot (Soft Concrete, Yellow) Pack of 3	\$96.00
QC1B-MC-0030	30-Grit Single Dyma-Dot (Medium Concrete, Grey) Pack of 3	\$96.00
QC1B-HC-0030	30-Grit Single Dyma-Dot (Hard Concrete, Red) Pack of 3	\$96.00
QCAR-MC-0030	30-Grit Dyma-Arrow (Medium Concrete) LH (Grey) (Single & Dual-Disc Grinders) Pack of 3	\$145.00
QCAR-MC-0030-R	30-Grit Dyma-Arrow (Medium Concrete) RH (Black) (Dual-Disc Grinders Only) Pack of 3	\$145.00
QCAR-SC-0030-L	30-Grit Dyma-Arrow (Soft Concrete) LH (Yellow) (Single & Dual-Disc Grinders) Pack of 3	\$145.00
QCAR-SC-0030-R	30-Grit Dyma-Arrow (Soft Concrete) RH (Green) (Dual-Disc Grinders Only) Pack of 3	\$145.00

Magna-Trap PRO-Tooling (cont.)

PART#	ITEM	MSRP
QC2C-PCD	Dyma-Crush, Pack of 3	\$403.00
QC-SPIKES	Magna Spikes (Each)	\$135.00
QC-PCD1-L	Dyma-PCD LH (Blue) (Single & Dual-Disc Grinders) Pack of 3	\$210.00
QC-PCD1	Dyma-PCD RH (Black) (Dual-Disc Grinders Only) Pack of 3	\$210.00
M401PL	Economy REMOVAL Tool Blister Pack (PCD's) LEFT HAND, BLUE	\$105.00
M401PR	Economy REMOVAL Tool Blister Pack (PCD's) RIGHT HAND, BLACK	\$105.00

PRO-Polishing New Products (Each)

PART#	ITEM	MSRP
QC-AD-3-EDCO	Magna-Trap Velcro Adapter For 3" Pucks	\$75.00
MRPTD7630	3" 30 Grit Premium Metal Resin Puck Velcro Back	\$40.00
MRPTD7650	3" 50 Grit Premium Metal Resin Puck Velcro Back	\$40.00
MRPTD76100	3" 100 Grit Premium Metal Resin Puck Velcro Back	\$40.00
MRPTD76200	3" 200 Grit Premium Metal Resin Puck Velcro Back	\$40.00
MRPTD76400	3" 400 Grit Premium Metal Resin Puck Velcro Back	\$40.00
PTD7630	3" 30 Grit Premium Resin Puck Velcro Back	\$40.00
PTD7650	3" 50 Grit Premium Resin Puck Velcro Back	\$30.00
PTD76100	3" 100 Grit Premium Resin Puck Velcro Back	\$30.00
PTD76200	3" 200 Grit Premium Resin Puck Velcro Back	\$30.00
PTD76400	3" 400 Grit Premium Resin Puck Velcro Back	\$30.00
PTD76800	3" 800 Grit Premium Resin Puck Velcro Back	\$30.00
PTD761500	3" 1500 Grit Premium Resin Puck Velcro Back	\$30.00
PTD763000	3" 3000 Grit Premium Resin Puck Velcro Back	\$30.00

Magna-Trap Display Stand

PART#	ITEM	MSRP
99065	Magna-Trap® Display Stand w/Rolling Base	\$1,745.00
99070	Magna-Trap® Countertop Display	\$240.00
99060-1	Magna-Trap® Display Stand Baskets (Box Of 3)	\$130.00



MAGNA-TRAP®
DISPLAY STAND W/ROLLING BASE



NEW PRODUCTS EDCO SYNTEC PRO-TOOLING

Conversion Accessories & Plates For Planetary Grinders to Magna-Trap

PART#	ITEM	MSRP
QCRL-MT-Holder	Adapter For Husq Redilock To Use Magna- Trap Tooling (Each) (3 Needed Per Plate)	\$68.00
FCHUSQ280-SF	Convert Husq Pg280 To Magna- Trap Plate (11")	\$300.00
FCHUSQ280V2-SF	Convert Husq Pg280 V2 To Magna- Trap Plate (11")	\$335.00
FCHUSPG400-A	Convert Husq Pg400 To Magna- Trap Disc (16")	\$390.00
FCHUSQ450-SF	Convert Husq Pg450 To Magna- Trap Plate (7")	\$200.00
FCHUSQ680-SF	Convert Husq Pg680 To Magna- Trap Plate (9")	\$255.00
FCPLTHQV-SF	Convert Husq Pg690 & Pg820 To Magna- Trap (10.5")	\$255.00
LWQRSAS185-SF	Convert Sase/Diamatic 555/580 To Magna- Trap (7.5")	\$220.00
LWQRSAS240-SF	Convert Sase/Diamatic 780 To Magna- Trap Plate (9.5")	\$221.00
QR250STD-SF	Convert Blastrac Pg250 To Magna- Trap Plate (10")	\$222.00
SFHOLDER-M	Fully Machined Magna- Trap Holder W/ Magnet	\$30.00

Replacement Heavy Duty Bush Hammers & Accessories

PART#	ITEM	MSRP
BHLG45	Large Bush Hammer W/ Grease Fitting (Bolt On Style)	\$111.00
BHLG45-SF	Large Bush Hammer (Magna-Trap Style)	\$170.00
FCPLTHQV-HD-BH	Convert Husq Pg690 & Pg820 With 3 Large Bush Hammers Included	\$575.00
LWQRSAS240-BH	Convert Sase/Diamatic 780 With 3 Large Bush Hammers	\$575.00

Burnishing Pads 20" and 27"

PART#	ITEM	MSRP
SPSP508-800	20" 800 Grit Pro Burnishing Pad (Pack Of 5)	\$300.00
SPS508-1500	20" 1500 Grit Pro Burnishing Pad (Pack Of 5)	\$300.00
SPS508-3000	20" 3000 Grit Pro Burnishing Pad (Pack Of 5)	\$300.00
SPS508-BUFF	20" Buff Grit Pro Burnishing Pad (Pack Of 5)	\$300.00
SPSP686-800	27" #800 Grit Pro Burnishing Pad (Pack Of 5)	\$600.00
SPSP686-1500	27" #1500 Grit Pro Burnishing Pad (Pack Of 5)	\$600.00
SPSP686-3000	27" #3000 Grit Pro Burnishing Pad (Pack Of 5)	\$600.00
SPS686-BUFF	27" Buff Grit Resin Burnishing Pad (Pack Of 5)	\$600.00
SPSP508-MULTI	Multi Pack Of 20" Burnisher Pad (1 Ea. 800 Grit, 1500 Grit, Buff, 2 Ea. 3000 Grit)	\$300.00
SPSP686-MULTI	Multi Pack Of 27" Burnisher Pad (1 Ea. 800 Grit, 1500 Grit, Buff, 2 Ea. 3000 Grit)	\$600.00

7" Hand Held Grinders Cupwheels & Polishing Pads (Only for Hand Held Grinders)

PART#	ITEM	MSRP
W24-230KITCONV	Metabo 7" 6600 Rpm 15amp Angle Grinder W/ 7" Prem Convertible Dust Shroud & Loop Handle	\$890.00
SCARSTD180	7" Premium Arrow Cupwheel 10seg Non-Threaded 5/8 & 7/8 Arbor	\$170.00
CFLO34	Cupwheel Adapter Nut Set (Needed For 7" Arrow Cupwheel)	\$40.00
SC9P0007	7" Flexible Backing Pad	\$65.00
ALUM178	7" Aluminum Backing Pad	\$80.00
SC9P7050	7" Resin 50 Grit Polishing Pads Wet/Dry	\$44.00
SC9P7010	7" Resin 100 Grit Polishing Pads Wet/Dry	\$44.00
SC9P7020	7" Resin 200 Grit Polishing Pads Wet/Dry	\$44.00
SC9P7040	7" Resin 400 Grit Polishing Pads Wet/Dry	\$44.00
SC9P7080	7" Resin 800 Grit Polishing Pads Wet/Dry	\$44.00
SC9P7150	7" Resin 1500 Grit Polishing Pads Wet/Dry	\$44.00
SC9P7300	7" Resin 3000 Grit Polishing Pads Wet/Dry	\$44.00

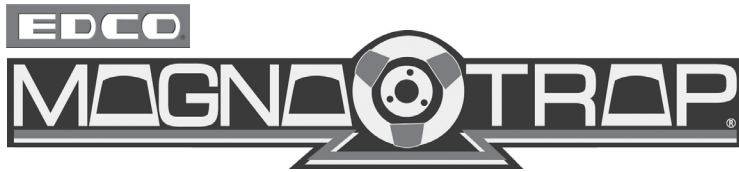

FLOOR GRINDER & TURBO GRINDER ACCESSORIES

Magna-Trap Floor Grinder Classic Accessories

PART#	ITEM	MSRP
19360	Slide-on Holding Case for PCDyma-Serts & Dyma-Serts	\$72.00
19110	Dyma-Sert 1X General Purpose	\$134.00
19130	Dyma-Sert 2X Medium Matrix	\$134.00
19180	Dyma-Sert 3X Hard Matrix	\$134.00
12407	4-Sided Carbide Tungserts Replacement 6 Pack	\$151.00
12424	Strip-Sert Assembly Complete- RH	\$222.00
12420	Strip-Sert Assembly Complete - LH	\$222.00
77630R	Stone Holder - RH	\$76.00
77630L	Stone Holder - LH	\$76.00
100054	10" Universal Magna-Trap Disc ONLY (SEC, 2EC-NG, 2GC-NG, TG10)	\$314.00
100053	10" Magna-Trap Disc Assembly w/Hub (SEC, 2EC-NG, 2GC-NG Only)	\$439.00
77506	Weight Block 40lbs (2 Required for Dual-Disc)	\$164.00
101201	Magna-Trap Conversion Disc (Dual-Disc Grinders Only)	\$489.00
77535	Magna-Trap Flex Head Disc Assembly (2 required for dual disc HD grinders only)	\$781.00



WEIGHT BLOCKS

7" TURBO GRINDER Classic Accessories

PART#	ITEM	MSRP
72029	7" Diamond Cupwheel, Dry - Hard Bond	\$187.00
72030	7" Diamond Cupwheel, Dry - Medium Bond	\$187.00
72042	7" PCD Cupwheel w/ backer segment	\$295.00
SCARSTD180	7" Premium Arrow Cupwheel 10SEG non-threaded 5/8 & 7/8 Arbor	\$170.00
100294	7" Multi-Tooling Disc with Carbide Pockets (TMC-7 Only)	\$267.00
72312	TMC-7, 7" Rigid-Head Assembly w/complete round shroud	\$692.00
72313	TMC-7, 7" Flex-Head Assembly w/cropped shroud	\$692.00
72040	7" Scarifier Disc Assembly	\$171.00
72050	Replacement Carbides for 7" Scarifier Disc Assembly (15 Required)	\$11.00



7" DIAMOND CUPWHEEL



10" - 20 SEGMENT DIAMOND DISC

10" TURBO GRINDER Classic Diamond Accessories

PART#	ITEM	MSRP
100054	10" Universal Magna-Trap Disc ONLY (SEC, 2EC-NG, 2GC-NG, TG10)	\$314.00
19160	10" - 20 Segment Diamond Disc, Red, Medium Bond	\$375.00
19161	10" - 20 Segment Diamond Disc, White, Medium Bond - Abrasive Concrete	\$375.00
19162	10" - 20 Segment Diamond Disc, Orange, Soft Bond, 30/40 grit, Very Hard Applications	\$590.00
19165	10" - 20 Segment Diamond Disc, Premium Hard Bond	\$375.00
19167	10" - 10 Segment Diamond Disc, Silver Economy	\$100.00
19170	10" - 20 Segment Diamond Disc, General Purpose Economy	\$300.00

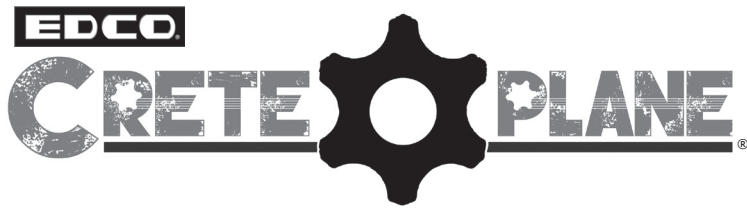

WALK-BEHIND & SELF-PROPELLED CRETE-PLANERS®

8" WALK-BEHIND Crete-Planer

PART#	MODEL	POWER	MSRP
79300	CPM-8G	9HP, Honda, w/78 Cutters & 215 Spacers Installed	\$7,900.00
79500	CPM-8E	5HP, 230V, 1Phase, w/78 Cutters & 215 Spacers Installed	\$7,900.00
72600	CPM-8P	10HP, Propane, w/78 Cutters, 215 Spacers Installed	\$11,450.00
79300PCD	CPM-8G	9PHP, Honda w/8" Diamond Flat drum w/feather control	\$16,234.00
79500PCD	CPM-8E	5HP, 230V, 1 Phase, w/8" Diamond Flat Drum w/feather control	\$16,234.00
72600PCD	CPM-8P	10HP, Propane, w/8" Diamond Flat Drum w/feather control	\$19,781.00



CRETE-PLANE®
CPM-8G

8" WALK-BEHIND SCARI-LITE Crete-Planer

PART#	MODEL	POWER	MSRP
69300	CPL-8E	1.5HP, 115V, Electric, w/66 Cutters & 234 Spacers Installed	\$5,173.00
69500	CPL-8G	5.5HP, Gasoline, w/66 Cutters & 234 Spacers Installed	\$5,173.00

CRETE-PLANE®
CPL-8E



10" WALK-BEHIND Crete-Planer

PART#	MODEL	POWER	MSRP
69100	CPM-10G	13Hp, Honda, 6-shaft w/ 102 Cutters & 252 Spacers Installed	\$9,215.00
69200	CPM-10E	7.5HP, 230/460V, 3Phase, 6-shaft w/ 102 Cutters & 252 Spacers Installed	\$9,215.00

CRETE-PLANE®
CPM-10G



10" SELF-PROPELLED Crete-Planer

PART#	MODEL	POWER	MSRP
73400	CPU-10FC-G	20HP, Honda, Includes 4-Shaft Drum Standard, No Cutters/Spacers	\$19,340.00
73600	CPU-10FC-E	10HP, 230/460V, 3Phase, Includes 4-Shaft Drum Standard, No Cutters/Spacers	\$19,340.00

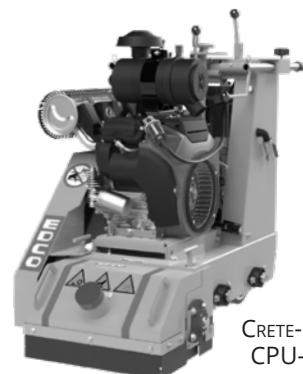

CRETE-PLANE®
CPU-10FC

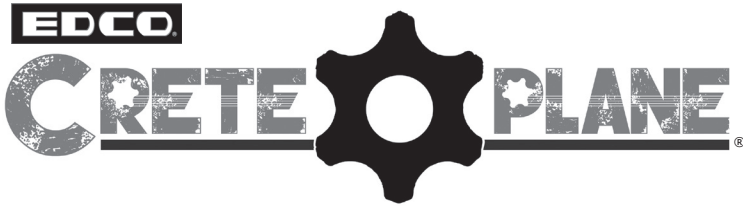

CUTTER ACCESSORY PACKAGES

CPM-8 Cutter Accessory Packages

PART#	ITEM	DESCRIPTION	MSRP
A201	CPM-8 Start-Up Pack 1	78 CP206-T, 215 Spacers, 6 Shafts	\$650.00
A202	CPM-8 Start-Up Pack 2	150 JRS501, 175 Spacers, 6 Shafts	\$468.00
A209	CPM-8 FINE Setup Start-Up Pack	96 CP206-T, 174 Spacers, 6 Shafts	\$750.00
A211	CPM-8 Edger/CPM-4 Carbide Cutter, 6 Shaft Start-Up Pack	54 CP206-T, 114 Spacers	\$450.00

CPL-8 Cutter Accessory Package

PART#	ITEM	DESCRIPTION	MSRP
A212	CPL-8 Start-Up Pack	66 CP206-T, 234 Spacers, 6 Shafts	\$625.00

CPM-10 Cutter Accessory Packages

PART#	ITEM	DESCRIPTION	MSRP
A207	CPM-10, 6 Shaft Start-Up Pack	102 - 308T, 252 Spacers, 6 Shafts	\$1,082.00
A208	CPM-10, 8 Shaft Start-Up Pack	152 - 206T, 384 Spacers, 8 Shafts	\$1,317.00

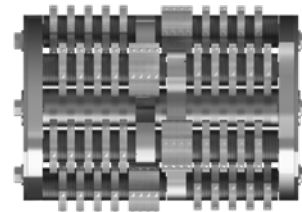

CPM-8 START-UP PACK
DRUM NOT INCLUDED
A201

CPU-10 Cutter Accessory Packages

PART#	ITEM	DESCRIPTION	MSRP
A210	CPU-10FC, 6 Shaft Start-Up Pack	96 CP308-T, 240 Spacers, 6 Shafts, 12 Bushings	\$1,128.00
A206	CPU-10FC, 4 Shaft Start-Up Pack	64 CP408-TV, 130 Spacers, 4 Shafts, 8 Bushings	\$808.00



EDCO
BLUE CARBIDE

CRETE-PLANE Cutters (non-packaged)

PART#	ITEM	MSRP
20156	CP206-T, 6 Point Tungsten Blue Carbide (CPM-8, CPM-10 8-Shaft, CPL-8 6-Shaft)	\$5.85
12206	JRS-501, 2" 18 Teeth Pointed Steel (CPM-8 & CPM-10 8-Shaft)	\$2.35
20206	CP305, 2" 12 Teeth Flat Tip Steel (CPM-8 & CPM-10 8-Shaft)	\$2.35
20336	CP207, Carbide Milling Cutter (CPM-8 & CPM-10 8-Shaft)	\$19.00
20326	CP308T, 2 1/4" Carbide (CPM-10 & CPU-10FC 6-Shaft)	\$8.57
20296	CP404-P6, Pointed Steel (CPM-10 & CPU-10FC 6-Shaft)	\$4.10
20076	CP404, 2 3/8" Flat Tip Steel (CPM-10 & CPU-10FC 6-Shaft)	\$4.10
20136	CP408-TV, Carbide (CPU-10FC 4-Shaft & CPU-12)	\$9.64
20236	CP204-P, 1 5/8" 18 Teeth Pointed Steel (CPL-8 6-Shaft)	\$1.00
20056	CP405P, 3" Pointed Steel (CPU-10FC 4-Shaft & CPU-12)	\$4.10
20086	CP405, 3" Flat Tip Steel (CPU-10FC 4-Shaft & CPU-12)	\$4.10
20316	12 Point Carbide Cutter (CPU-10FC 4-Shaft & CPU-12)	\$10.71



POINTED STEEL



FLAT-TIP STEEL

CRETE-PLANE Accessories

PART#	ITEM	MSRP
Model: CPM-8 Accessories		
65050	CPM-8 Drum Assembly, Includes 6-Shafts	\$642.61
65050C	CPM-8 Drum w/78 Carbide and 204 Spacers	\$1,195.00
65080	CPM-8 & CPM-10 Dust Control Water Mist Kit	\$85.25
65027	CPM-8 EDGER Assembly	\$433.02
C66040	Drum-4, use with edger, Includes 6-Shafts	\$545.37
20150	CP407 Shafts, for use on CPM-8, 8-9/16" x 1/2"	\$11.71
C66043	CP410 Shafts, use on CPM-4, 5-3/16" x 1/2"	\$12.87
12230	CG227, Steel Spacers	\$0.41
Model: CPL-8 Accessories		
66309	CPL-8 Drum Assembly 6-Shafts	\$436.00
66309C	CPL-8 Drum Assembly w/ Carbides & Spacers Loaded	\$956.00
Model: CPM-10 Accessories		
65270	CPM-10, 6- Shaft Drum	\$795.82
65270C	CPM-10 6-Shaft Drum W/ Carbides & Spacers Loaded	\$1,778.28
65280	CPM-10, 8-Shaft Drum	\$808.70
20170	CPM-10, 6-Shaft Shaft	\$17.55
20180	CPM-10, 8-Shaft Shaft	\$12.87
Model: CPU-10FC Accessories		
64420	CPU-10FC, 4-Shaft Drum	\$699.86
64430	CPU-10FC, 6-Shaft Drum	\$699.86
64450	CPU-10FC Outrigger Wheel Assembly	\$402.60
20120	CPU-10FC, Shaft, 11-3/8" for use on, 10" drum	\$16.39
20060	CP403, Spacer 1-1/20D x 3/4 ID	\$0.65
84063	CP403, Bushing, 3/4" ID	\$9.46

CRETE-PLANE PCDiamond Drums

PART#	ITEM	MSRP
Model: CPM-8 PCDiamond Drums		
65160	CPM-8, 8" PCDiamond Drum Flat Tooth Complete	\$9,283.00
65170	CPM-8, 4" PCDiamond Drum Flat Tooth Complete	\$6,260.00
65180	CPM-8 8" PCDiamond Drum 3 Land Round Complete	\$9,283.00
Model: CPM-10 PCDiamond Drums		
65360	CPM-10, 10" PCDiamond Drum Flat Tooth Complete	\$11,695.00
65370	CPM-10, 10" PCDiamond Drum Round Tooth Complete	\$11,695.00
Model: CPU-10FC PCDiamond Drums		
65460	CPU-10FC, 10" PCDiamond Drum Flat Tooth Complete	\$24,817.00
Model: CPM-8/CPM-10 PCDiamond Drums Blades		
65181	3 Tooth Inside Plate w/Diamond Flat	\$856.29
65182	3 Tooth Outside Plate w/Diamond Flat	\$901.21
65183	3 Tooth Inside Plate w/Diamond Round	\$856.29
65184	3 Tooth Outside Plate w/Diamond Round	\$901.21
Model: CPU-10FC PCDiamond Drums Accessories		
65466	9" - 6 Tooth Diamond Flat	\$1,757.50
65467	9" -6 Tooth Diamond Round	\$1,757.50



PCDIAMOND DRUM

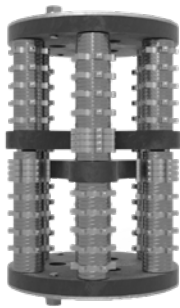

CPM-8
FULLY LOADED DRUM

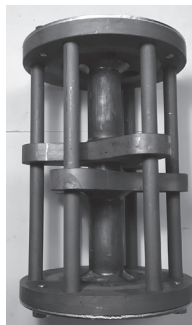

CPM-8 DRUM
ASSEMBLY



CRETE CRUSH

5 HEAD AIR POWERED CRETE CRUSH®

5 HEAD Crete-Crusher

PART#	MODEL	POWER	MSRP
63100	CD-5	5-Head Air, 160 CFM, w/5 - 5pt Bit	\$14,735.00



5-HEAD
CRETE-CRUSH®
CD-5

CRETE-CRUSH® Accessories

PART#	ITEM	MSRP
18810	5-Point Carbide Bit, CD-5 & CD-3	\$143.00
18820	9-Point Carbide Bit, CD-5 & CD-3	\$167.00
63220	Bit Removal Tool	\$91.28



9 POINT BIT



5 POINT BIT



BIT REMOVAL TOOL

TRAFFIC LINE REMOVER

PART#	MODEL	POWER	MSRP
77500	TLR-7	13HP Honda w/TR3-24	\$11,680.00

TRAFFIC LINE REMOVER



TRAFFIC LINE REMOVER
TLR-7

TRAFFIC LINE REMOVER Accessories

PART#	ITEM	MSRP
26010	TR3-24 (Set of 3)	\$920.00
26020	TR3-48 (Set of 3)	\$1,445.00



TR3-24 (SET OF 3)



TR3-48 (SET OF 3)



CRACK CHASING SAW & VACUUM SYSTEMS

10" CRACK CHASING Saw

PART#	MODEL	POWER	MSRP
49600	C-10	Gasoline, 13HP Honda, w/8X.375 Dia. Blade	\$6,415.00
49700	C-10	Electric, 5HP, 1 Phase, 230V, w/ 8" x .375 Dia. Blade	\$6,415.00



C-10

CRACK CHASING SAW Accessories

PART#	ITEM	MSRP
49015	C-10 Wheel Kit	\$108.33
CC0837P3	8x.375x1" V-Grooved Dia. Blade -Cured	\$310.00
CC0850P3	8x.500x1" V-Grooved Dia. Blade -Cured	\$369.00

VACUUM Systems

PART#	MODEL	POWER	MSRP
ED33125HCONK	VAC-200	200 CFM, HEPA 2.0, w/Hose	\$4,165.00
ED33125HCONDB	Bagger VAC	200 CFM, HEPA 2.0 w/ hose	\$5,975.00
ED33280K	VAC-290	290 CFM, HEPA 2.0 19 Amp, w/Hose	\$ 5,710.00
EDRB331PROLOK	VAC-330	Beast I, 330 CFM, Direct Bagger Vac, HEPA MAXX, w/ 3" 25' vac hose w/3" inlet and 3"-2" reducer	\$9,775.00
EDR331PROLOK	VAC-330DP	Beast II, 330 CFM Vac w/Dustpan, HEPA MAXX, w/ 3" 25' vac hose w/3" inlet and 3"-2" reducer	\$8,392.00



VAC-200

BEAST I
VAC-330

VACUUM SYSTEM Accessories

PART#	ITEM	MSRP
ED5004K	VAC-200, 2" Wand Floor Tool	\$491.58
ED5018	VAC-200, 32" Floor Sweep Kit	\$1,587.00
ED7004	VAC-290, 32" Floor Sweep Kit	\$1,837.00
ED5014D	2" to 1.5" Rubber Cuff Adapter,	\$30.00
ED16766901	Plastic Bags, Pack of 10, Vac-200, Vac-290, Vac-330DP	\$21.00
ED1631-6097	Continuous Replacement Vacuum Bag for the Vortex 330 (Beast I)	\$160.00
ED701225	3" x 25' Plastic Crush-Proof Hose	\$538.00
ED501425	2" x 25' Plastic Crush-Proof Hose	\$294.00



PLASTIC BAGS FOR
VAC-200, VAC-290, VAC-330DP

EPOXY SCREED Boxes

PART#	ITEM	MSRP
C90300	30" Epoxy Screed Box	\$651.00
C90400	36" Epoxy Screed Box	\$677.00

BEAST II
VAC-330DP





FLOOR STRIPPER & CHISEL SCALERS

8" TILE SHARK Floor Stripper

PART#	MODEL	POWER	MSRP
94400	TS-8	Tile Shark 3/4HP, 115V, includes pack of 8" Rigid Blades	\$2,629.00

TILE SHARK Accessories

PART#	ITEM	MSRP
28030	8" Flex Scraper Blade, Pack of 5	\$73.00
28040	8" Rigid Scraper Blade, Pack of 5	\$59.00
28050	8" Slicer Scraper Blade, Pack of 5	\$128.00
28060	12" Foam Rubber Backing Blade, Pack 5	\$69.00

BIG STICK Air Powered Chisel Scalars

PART#	MODEL	POWER	MSRP
27200	ALR-BS-Straight	5 ft. Straight Big Stick, includes one 3" Chisel, Requires 12-15 cfm @ 90 PSI	\$2,439.00
27100	ALR-BS-Ergo	5 ft. Ergonomic Big Stick, includes one 3" Chisel, Requires 12-15 cfm @ 90 PS	\$2,439.00

ALR Air Powered Chisel Scalars

PART#	MODEL	POWER	MSRP
C10342	ALR-E	Ergonomic, w/4" Chisel (18lbs.), Requires 6-8 CFM @ 90 PSI	\$1,545.00
C10301	ALR-5	5 ft. Steel, w/4" Chisel (16lbs.), Requires 6-8 CFM @ 90 PSI	\$1,545.00
C10308	ALR-4	4 ft. Steel, w/4" Chisel (12.5lbs), Requires 6-8 CFM @ 90 PSI	\$1,366.00
C10309	ALR-2	2ft. Steel w/4" Chisel (9lbs.), Requires 6-8 CFM @ 90 PSI	\$1,309.00
C10301A	ALR-5A	5 ft. Aluminum w/4" Chisel (8lbs. 9oz.), Requires 6-8 CFM @ 90 PSI	\$1,472.00
C10308A	ALR-4A	4 ft. Aluminum w/4" Chisel (6lbs. 13oz.), Requires 6-8 CFM @ 90 PSI	\$1,436.00
C10309A	ALR-2A	2 ft. Aluminum w/4" Chisel (5lbs. 13oz.), Requires 6-8 CFM @ 90 PSI	\$1,363.00



TILE SHARK TS-8



5' ERGO ALR-E



BIG STICK ALR-BS-ERGO



ALR-4A



ALR-2



AIR POWERED CHISEL SCALER ACCESSORIES

BIG STICK & ALR Accessory Packages

PART#	ITEM	DESCRIPTION	MSRP
27060	Big Stick Accessory Package	2" Chisel, 3" Chisel, Two-3" Milled Chisels, 6" Scraper Blades (5 Pack), a Chipping Point	\$514.00
C10341	ALR Starter Package (No Stand)	1" Chisel, 2" Chisel, Two-4" Milled Chisels, One Package of 4" & 8" Scraper Blades	\$518.04

BIG STICK Accessories

PART#	ITEM	MSRP
27031	Big Stick, 2" Single Bevel Chisel	\$91.00
27033	Big Stick, 3" Single Bevel Chisel	\$91.00
27034	Big Stick, 3" Milled Chisel Adapter	\$122.00
27035	Big Stick, 6" Scraper Blades (pack of 5)	\$160.00
27037	Big Stick, Chipping Point	\$75.00

ALR Accessories

PART#	ITEM	MSRP
C10302	4" Steel Chisel	\$70.22
C10303	2" Steel Chisel	\$70.22
C10324	1 1/4" Steel Chisel	\$70.22
C10306	LR-4M Chisel Adapter	\$121.07
C10329	4" Scraper Blades (5 Pack)	\$69.05
C10304	8" Scraper Blades (5 Pack)	\$84.28
C10305	12" Scraper Blades (5 Pack)	\$102.75
C10327	MPT Chipping Point	\$56.18
C10320	Curved Joint Cleaner, 7/16" width	\$160.33
C10353	Curved Joint Cleaner, 5/8" width	\$194.27
C10354	Curved Joint Cleaner, 7/8" width	\$186.08
C10339	Shingle Remover Chisel	\$253.96
C10323	8" Shingle Remover Blades (5 Pack)	\$135.08



4" STEEL CHISEL



2" STEEL CHISEL

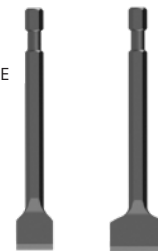

BIG STICK, 2" SINGLE BEVEL CHISEL

BIG STICK, 3" SINGLE BEVEL CHISEL

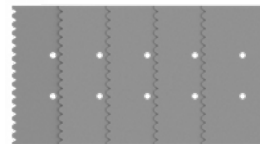

8" SHINGLE REMOVER BLADES (5 PACK)

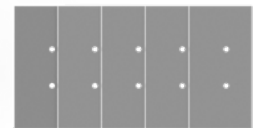

8" SCRAPER BLADES (5 PACK)



CURVED JOINT CLEANER, 7/16" WIDTH



CONCRETE & ASPHALT SAWS

14", 18" & 20" WALK-BEHIND Saws

PART#	MODEL	POWER	MSRP
39200	KL-14	Gasoline, 6.5HP Honda	\$2,509.00
39600	KL-18	Gasoline, 13HP Honda 18" single arbor	\$3,252.00
37300	DS-18E	Electric, 5HP, 230V, 1Phase, 60Hz	\$5,290.00
30100	DS-20	Gasoline, 13HP Honda 20" dual arbor	\$3,558.00
30300	DS-20E	Electric, 7.5HP, 230V, 3 phase	\$5,090.00



KL-14

20", 24" & 30" SELF-PROPELLED Saws

PART#	MODEL	POWER	MSRP
32600	SS-20	Gasoline, 20HP Honda	\$12,087.00
34600	SS-20	Propane, 25HP Kohler	\$13,361.00
33100	SS-20	Electric, 10HP, 3 Phase, 230/460V	\$10,647.00
38100	SS-24	Gasoline, 24HP Honda	\$13,671.00
38200	SS-24	Propane, 25HP Kohler	\$14,088.00
31400	SS-30	Gasoline, 35HP Kohler	\$22,609.00
34300	SS-30	Electric, 15HP, 3 Phase, 230/460V	\$22,747.00



DS-20

WALK-BEHIND & SELF-PROPELLED SAW Accessories

PART#	ITEM	MSRP
300093	Water Tank Assembly Option KL-14	\$245.00
56310	Water Tank Assembly Option, KL-18, DS-18, DS-20	\$237.00
51275	Water Tank Assembly Option SS-20	\$345.00
51460	Water Tank Assembly Option SS-24	\$359.00



SS-24



MASONRY & TILE SAWS

14" & 20" MASONRY Saws

PART#	MODEL	POWER	MSRP
22300	BB-14	Electric, 1.5HP, 1 Phase, 60Hz, 115/230V	\$3,472.00
26300	BB-14	Gasoline, 5.5HP Honda	\$3,923.00
26500	BB-14	Gasoline, 9HP Honda	\$4,696.00
22500	GMS-20	Gasoline, 9HP Honda	\$6,612.00
27700	GMS-20	Gasoline, 13HP Honda	\$7,199.00
27700ES	GMS-20	Electric Start 12V, 13HP	\$8,311.00
21200	MS-20	Electric, 5HP, 1Phase, 60Hz	\$7,224.00
21300	MS-20	Electric, 7.5HP, 3Phase, 60Hz	\$7,987.00

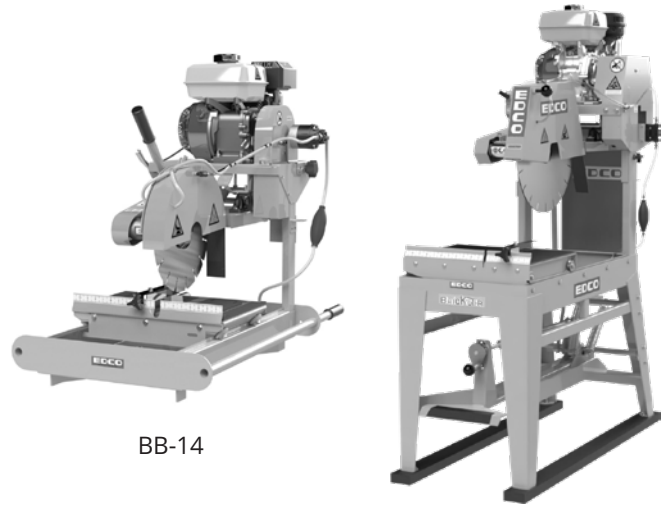

BB-14

GMS-20

14" MASONRY SAW Accessories

PART#	ITEM	MSRP
40632	BB-14 Foot Pedal Kit	\$167.00
40631	14" Masonry Saws Universal Folding Stand	\$220.00
24950	14" Masonry Saws Universal ProCart	\$824.00
40091	14" Masonry Saw Tote-A-Saw Kit	\$98.00



TMS-7

TILE Saws

PART#	MODEL	POWER	MSRP
24200	TMS-10	Electric, 1.5HP	\$2,977.00
29500	TMS-7	Electric, .5HP w/Cart & Diamond Blade	\$2,700.00

TILE SAW Accessories

PART#	ITEM	MSRP
24150	Upright Stand	\$122.00
42149	Tile Accessory Package (90° Protractor, 45° Angle & 45° Miter)	\$103.00
42160	Straight Cut Guide	\$20.00
PRW1006S	10" Tile Saw Blade, Wet, Standard, 10" x .060 x 5/8	\$63.00
PRW0710P	7" Tile Saw Blade	\$55.00



TMS-10



CONCRETE/ASPHALT SAW BLADES

Concrete/Asphalt Saw Blades

PART#	ITEM	MSRP
HG1412V3	14" x .125 x 1" Dia. Blade for General Concrete	\$106.00
HU1412V4	14" x .125 x 1" Dia. Blade for Universal	\$122.00
HH1412V1	14" x .125 x 1" Dia. Blade for Hard Concrete	\$106.00
HA1412V5	14" x .125 x 1" Dia. Blade for Asphalt/Green Concrete	\$172.00
HG1812V3	18" X .125 X 1" Dia. Blade for General Concrete	\$194.00
HU1812V4	18" x .125 x 1" Dia. Blade for Universal	\$270.00
HA1812V5	18" X .125 X 1" Dia. Blade for Asphalt/Green Concrete	\$186.00
HG2014V3	20" x .140 x 1" Dia. Blade for General Concrete	\$279.00
HA2012V5	20" x .125 x 1" Dia. Blade for Asphalt/Green Concrete	\$295.00
HH2014S1	20" x .140 x 1" Dia. Blade for Hard Concrete	\$320.00
HU2012V4	20" x .125 x 1" Dia. Blade for Universal	\$370.00
WC2414V3	24" x .140 x 1" Dia. Blade for Concrete	\$652.00
WA2414V5	24" x .140 x 1" Dia. Blade for Asphalt/Green Concrete	\$795.00
WC2615V3	26" x .150 x 1" Dia. Blade for Concrete	\$837.00
WC3015V3	30" x .150 x 1" Dia. Blade for Concrete	\$1,056.00
WA3015V5	30" x .140 x 1" Dia. Balde for Asphalt/Green Concrete	\$1,345.00



18" x .125 1" UNIVERSAL DIAMOND BLADE



20" x .140 1" DIAMOND BLADE
FOR GENERAL CONCRETE



14" x .125 1" UNIVERSAL DIAMOND BLADE

HH, HA, HG & HU blades are laser welded for both wet or dry applications.

HG	General Purpose Concrete. Can be used on Masonry Saws.
HU	Universal Blade.
V4	Harder Bond for abrasive materials. Can be used for Asphalt.
HA	Asphalt Blade, very abrasive applications
HH	For Hard Materials, softer bond

WA & WC blades are solder welded and are WET only applications.

WC	Wet only, Concrete.
WA	Wet only, Asphalt.



LIFT & SHIFT

Engine Hoist

PART#	MODEL	ITEM	MSRP
99500	EH1500KIT	Engine Hoist w/Carrier Cart	\$3,168.00
99501	EHCART	Carrier Cart Only	\$753.00



CARRIER CART ONLY



ENGINE HOIST w/
CARRIER CART



ENGINE HOIST



TRENCHER

Trencher

PART#	MODEL	ITEM	MSRP
87300	TR-18	18" Trencher	\$4,553.00

Trencher Accessories

PART#	ITEM	MSRP
101357	Digging Chain 3", Welded, TR-18	\$727.00
101385	Digging Chain 4", Welded, TR-18	\$769.00



18" TRENCHER



CLASSIC FLOOR GRINDER ACCESSORIES

CLASSIC FLOOR GRINDER Accessories

PART#	ITEM	MSRP
19110	Dyma-Sert, 1X, General Purpose	\$134.00
19130	Dyma-Sert, 2X, Medium Matrix	\$134.00
19180	Dyma-Sert, 3X, Hard Matrix	\$134.00
19155	PCDyma-Sert	\$134.00
12400	Strip-Sert Complete	\$136.00
12407	4-Sided Carbide Tungserts Replacement Pack (6)	\$151.00
19120	Holding Case for Dyma-Serts	\$27.00
11014	Stone, Coarse, C10	\$7.03
11074	Stone, Super Coarse C10-S	\$7.03
11024	Stone, Medium, C24	\$7.03
11034	Stone, Fine, C80	\$7.03
11084	Stone, Super Fine, C120	\$7.03
12160	Wood Wedge	\$0.45
12114	Scarifier Assembly Holding Case	\$31.00
12120	Scarifier Assembly	\$39.00
12130	Scarifier Assembly-HD, Heavy Duty	\$48.00
12170	Wire Brush w/Wedge	\$14.30
77050	Weight Tray (2EC/GC)	\$76.07
77049	55lb Weight	\$123.00
8888	Multi-Accessory Disc-Right Hand	\$234.07
9999	Multi-Accessory Disc- Left Hand	\$234.07
2222	Surfacer Disc - Right Hand Assembly	\$349.93
3333	Surfacer Disc - Left hand Assembly	\$349.93

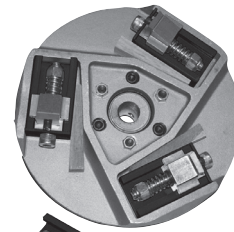

STRIP-SERTS
w/MULTI-ACCESSORY DISC

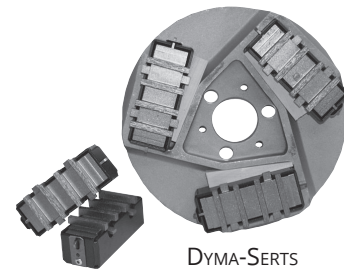

DYMA-SERTS
w/MULTI-ACCESSORY DISC



55LB WEIGHT

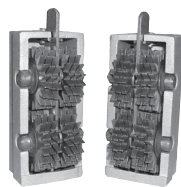

SCARIFIER ASSEMBLY
w/HOLDING CASE

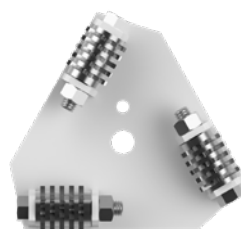

SURFACER DISC

This page is intentionally left blank.

This page is intentionally left blank.



CONCRETE KNOWLEDGE

**Training available 24/7 visit EDCOed.com
Scan the QR Code Below to Learn More**



EQUIPMENT DEVELOPMENT COMPANY, INC.

100 Thomas Johnson Dr.
Frederick, MD, 21702 USA
800.638.3326 • EDCOinc.com • sales@edcoinc.com